

PILOUS  
PILOUS-TMJ

Manual

Gravitation

Hydraulic gravitation

Hydraulic

Hydraulic NC automat

Hydraulic

Hydraulic NC automat

Special



2012
Made in EU

ARG 105 mobil

1385×13×0,65



ARG 105 mobil

	90°	+45°	+60°
●	105	70	40
■	105	65	40
■	105×110	65×85	40×45
⚡	0,65 kW	75 m/min.	27 kg

ARG 130 mobil

1730×13×0,65



ARG 130

1730×13×0,65



ARG 130 super

1730×13×0,65



ARG 130 / ARG 130 super / ARG 130 mobil

	90°	+45°	+60°
●	130	115	70
■	130	105	60
■	180×100	115×75	70×60
⚡			kg
ARG 130	230 V / 0,6 kW	75 m/min.	69,5/99 kg
	400 V / 0,45 kW	40/80 m/min.	69,5/99 kg
ARG 130 super	230 V / 0,6 kW	75 m/min.	70,5/100 kg
	400 V / 0,45 kW	40/80 m/min.	70,5/100 kg
ARG 130 mobil	230 V / 0,55 kW	75 m/min.	48 kg

ARG 200



2490×20×0,9



ARG 200

	90°	+45°	+60°
●	200	155	95
■	200	130	60
■	250×80	160×180	100×45

ARG 220



2600×27×0,9



ARG 220

	90°	+45°	+60°
●	220	170	105
■	220	155	75
■	285×90	175×80	105×75

ARG 200 plus



2490×20×0,9



ARG 200 plus

	90°	-45°	+45°	+60°
●	200	135	155	95
■	200	115	130	65
■	245×80	155×60	155×70	95×45

ARG 220 plus

	90°	-45°	+45°	90°
●	220	150	170	105
■	220	130	155	75
■	285×90	175×65	175×80	105×75

ARG 220 plus



2600×27×0,9



VP



	●	■	■
ARG 200	400 V / 1,05 kW	40/80 m/min.	230 kg
ARG 200 plus	400 V / 1,05 kW	40/80 m/min.	255 kg
ARG 220	400 V / 1,5 kW	40/80 m/min.	250 kg
ARG 220 plus	400 V / 1,5 kW	40/80 m/min.	270 kg

ARG 250

2710×27×0,9



VP

ARG 250 / H / S.A.F.

	90°	+45°	+60°
●	250	180	110
■	240	170	110
■	290×80	180×90	110×120

ARG 250 plus E

2710×27×0,9



ARG 250 plus E

	90°	-45°	+45°	+60°
●	250	170	180	110
■	240	150	170	110
■	300×75	175×75	180×90	110×120

ARG 250 plus

2710×27×0,9



HVP

	400 V / 1,5 kW	40/80 m/min.	kg
ARG 250	400 V / 1,5 kW	40/80 m/min.	320 kg
ARG 250 H	400 V / 2 kW	40/80 m/min.	340 kg
ARG 250 S.A.F.	400 V / 2,8 kW	15-90 m/min.	445 kg
ARG 250 plus E	400 V / 1,5 kW	40/80 m/min.	285 kg
ARG 250 plus	400 V / 1,5 kW	40/80 m/min.	465 kg
ARG 250 plus H	400 V / 2 kW	40/80 m/min.	485 kg
ARG 250 plus S.A.F.	400 V / 2,8 kW	15-90 m/min.	550 kg

ARG 250 plus S.A.F.

2710×27×0,9



ARG 250 plus / H / S.A.F.

	90°	-45°	+45°	+60°
●	250	175	180	110
■	240	160	170	110
■	290×80	175×80	180×90	110×120

ARG 300

3110×27×0,9



ARG 300 plus

3110×27×0,9



ARG 300 / H / S.A.F.

	90°	+45°	+60°
●	300	240	150
■	290	220	145
■	370×185	240×120	150×100

ARG 300 plus / H / S.A.F.

	90°	-45°	+45°	+60°
●	300	220	240	150
■	290	190	220	145
■	370×185	240×100	240×120	150×100

ARG 300 plus S.A.F.



3110×27×0,9



VP



HVP



ARG 300	400 V / 1,8 kW	35/75 m/min.	420 kg
ARG 300 H	400 V / 2,3 kW	35/75 m/min.	440 kg
ARG 300 S.A.F.	400 V / 2,8 kW	15-90 m/min.	545 kg
ARG 300 plus	400 V / 1,8 kW	35/75 m/min.	570 kg
ARG 300 plus H	400 V / 2,3 kW	35/75 m/min.	590 kg
ARG 300 plus S.A.F.	400 V / 2,8 kW	15-90 m/min.	645 kg

ARG 400 plus S.A.F.

4300×34×1,1



HD / LG



CD



AG



KD



SD



HVP

ARG 400 plus S.A.F.				
	90°	-45°	+45°	+60°
●	400	290	290	190
■	380	250	270	180
■	480×150	300×170	290×170	180×180
⚡	400 V / 3,6 kW		20-90 m/min.	1005 kg

ARG 500 plus S.A.F.



6040×41×1,3



ARG 380 plus S.A.F.



4950×34×1,1



ARG 380 plus S.A.F.

	90°	-45°	+45°	+60°
●	380	380	380	270
■	340	340	340	255
■	510×340	350×340	350×340	235×340
⚡	400 V / 3,6 kW		20-90 m/min.	1025 kg

ARG 500 plus S.A.F.

	90°	-45°	+45°	+60°
●	500	490	485	345
■	450	440	435	315
■	620×450	440×450	430×450	315×400
⚡	400 V / 4,7 kW		20-90 m/min.	1530 kg

ARG 250 CF-NC automat



2710×27×0,9



ARG 250 CF-NC automat			
	90°	+45°	
●	250	180	
■	245	170	
■	245×250	180×120	
ARG 250 DF-NC automat	400 V / 2,8 kW	15-90 m/min.	740 kg
ARG 250 CF-NC automat	400 V / 3 kW	15-90 m/min.	740 kg

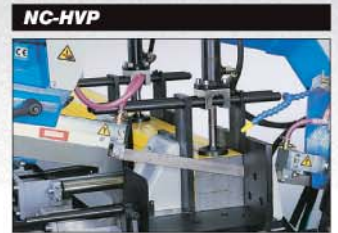

ARG 300 CF-NC automat



3110×27×0,9



ARG 300 CF-NC automat			
	90°	+45°	
●	300	240	
■	285	220	
■	305×290	235×130	
ARG 300 DF-NC automat	400 V / 2,8 kW	15-90 m/min.	925 kg
ARG 300 CF-NC automat	400 V / 3 kW	15-90 m/min.	925 kg



ARG 640 S.A.F.



8100×54×1.6



ARG 640 S.A.F.

	90°	+45°	+60°
●	640	640	375
■	550	550	375
■	1100×550	710×550	375×550

	400 V / 9,2 kW
	20-90 m/min.
	4300 kg

IR 200

ARG 1100 special



ARG 1100 special

■			
1100×100 (600)	400 V / 5,3 kW	50-190 m/min.	2800 kg

PP 301 / PP 361 / PP 501



3660×27×0,9 301

4400×34×1,1 361

4400×34×1,1 501

STANDARD



PP 301			
	90°	+45°	+60°
●	305	255	175
■	305	255	175
■	360×305	255×305	175×305
	400 V / 1,5 kW	16–73 m/min.	750 kg

PP 361			
	90°	+45°	+60°
●	360	305	215
■	360	305	215
■	430×360	305×360	215×360
	400 V / 2,2 kW	18–80 m/min.	1050 kg

PP 501			
	90°	+45°	+60°
●	400	305	215
■	400	305	215
■	500×400	305×400	215×400
	400 V / 2,2 kW	18–80 m/min.	1050 kg

PP 302 / PP 362 / PP 502 / PP 602



302 3660×27×0,9

362 4400×34×1,1

502 5600×41×1,3

602 6200×41×1,3



OPTIONS



PP 302	
	90°
●	305
■	305
■	360×305
	400 V / 1,5 kW 16–73 m/min. 780 kg

PP 362	
	90°
●	360
■	360
■	430×360
	400 V / 2,2 kW 18–80 m/min. 1090 kg

PP 502	
	90°
●	500
■	500
■	500×500
	400 V / 4 kW 12–100 m/min. 1450 kg

PP 602	
	90°
●	600
■	600
■	600×600
	400 V / 4 kW 14–120 m/min. 1750 kg

PP 302 G / PP 362 G / PP 502 G / PP 602 G



302	3660×27×0,9	362	4400×34×1,1
502	5600×41×1,3	602	6200×41×1,3



STANDARD

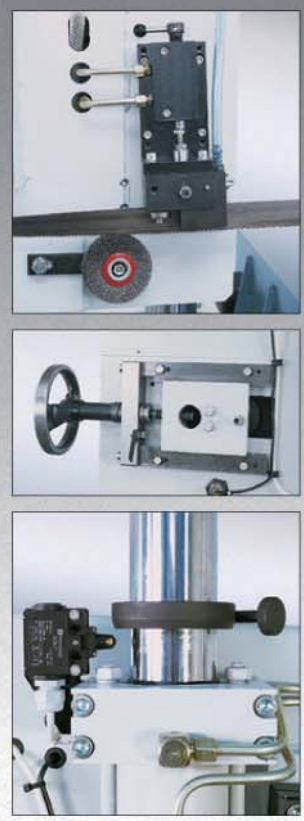

PP 362 G

	90°	+45°	+60°
●	360	305	215
■	360	305	215
■	430×360	305×360	215×360

400 V / 2,2 kW 18-80 m/min. 1090 kg

PP 502 G

	90°	+45°	+60°
●	500	370	255
■	500	370	255
■	500×500	370×500	255×500

400 V / 4 kW 12-100 m/min. 1450 kg

PP 302 G

	90°	+45°	+60°
●	305	255	175
■	305	255	175
■	360×305	255×305	175×305

400 V / 1,5 kW 16-73 m/min. 780 kg

PP 602 G

	90°	+45°	+60°
●	610	420	270
■	610	420	270
■	610×610	420×610	270×610

400 V / 4 kW 14-120 m/min. 1750 kg

OPTIONS

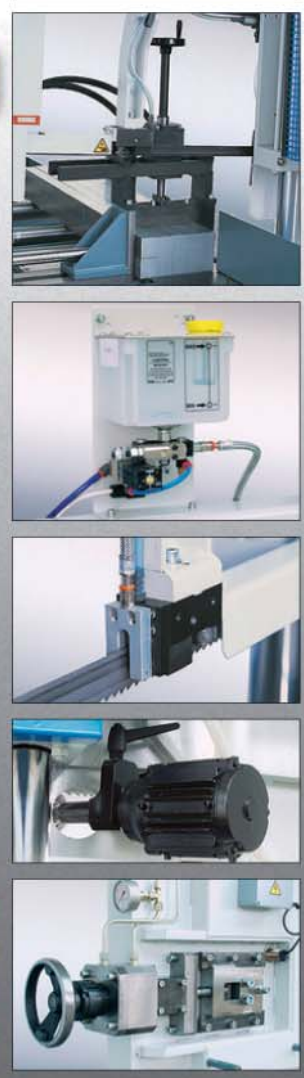

PP 301 A/CNC / PP 361 A/CNC / PP 501 A/CNC



● 90° 45° 60°

301	3660×27×0,9
361	4400×34×1,1
501	4400×34×1,1

PP 301 A / PP 301 CNC

	90°	+45°	+60°
●	305	255	175
■	305	255	175
■	360×305	255×305	175×305

400 V / 2,2 kW 10-100 m/min. 1170 kg

PP 361 A / PP 361 CNC

	90°	+45°	+60°
●	360	305	215
■	360	305	215
■	430×360	305×360	215×360

400 V / 3 kW 12-115 m/min. 1650 kg

PP 501 A / PP 501 CNC

	90°	+45°	+60°
●	400	305	215
■	400	305	215
■	500×400	305×400	215×400

400 V / 3 kW 12-115 m/min. 1650 kg

PP 302 A/CNC / PP 362 A/CNC / PP 502 A/CNC / PP 602 CNC

302 3660×27×0,9

362 4400×34×1,1



502 5600×41×1,3

602 6200×41×1,3



PP 362 CNC

STANDARD



PP 302 A / PP 302 CNC

●	90°
■	305
■	305
■	360×305

400 V / 2,2 kW 10–100 m/min. 1200 kg

PP 362 A / PP 362 CNC

●	90°
■	360
■	360
■	430×360

400 V / 3 kW 12–115 m/min. 1650 kg

PP 502 A / PP 502 CNC

●	90°
■	500
■	500
■	500×500

400 V / 4 kW 12–100 m/min. 2200 kg

PP 602 CNC

●	90°
■	600
■	600
■	600×600

400 V / 4 kW 14–120 m/min. 2550 kg

OPTIONS



PP 302 G A/CNC / PP 362 G A/CNC / PP 502 G A/CNC / PP 602 GCNC



3660×27×0,9 302

4400×34×1,1 362

5600×41×1,3 502

6200×41×1,3 602



PP 362 GA CNC

PP 302 GA / PP 302 GCNC

	90°	+45°	+60°
●	305	255	175
■	305	255	175
■	360×305	255×305	175×305

400 V / 2,2 kW 10–100 m/min. 1200 kg

PP 362 GA / PP 362 GCNC

	90°	+45°	+60°
●	360	305	215
■	360	305	215
■	430×360	305×360	215×360

400 V / 3 kW 12–115 m/min. 1650 kg

PP 502 GA / PP 502 GCNC

	90°	+45°	+60°
●	500	340	230
■	500	340	230
■	500×500	340×500	230×500

400 V / 4 kW 12–100 m/min. 2200 kg

PP 602 GCNC

	90°	+45°	+60°
●	610	420	270
■	610	420	270
■	610×610	420×610	270×610

400 V / 4 kW 14–120 m/min. 2550 kg

PP 602 L/CNC

6200×41×1,3



PP 602 L/CNC

	90°	
●	600	
■	600	
■	600×600	
400 V / 4 kW	10–100 m/min.	2550 kg

PP 620 DG / PP 620 DGA

6420×41×1,3

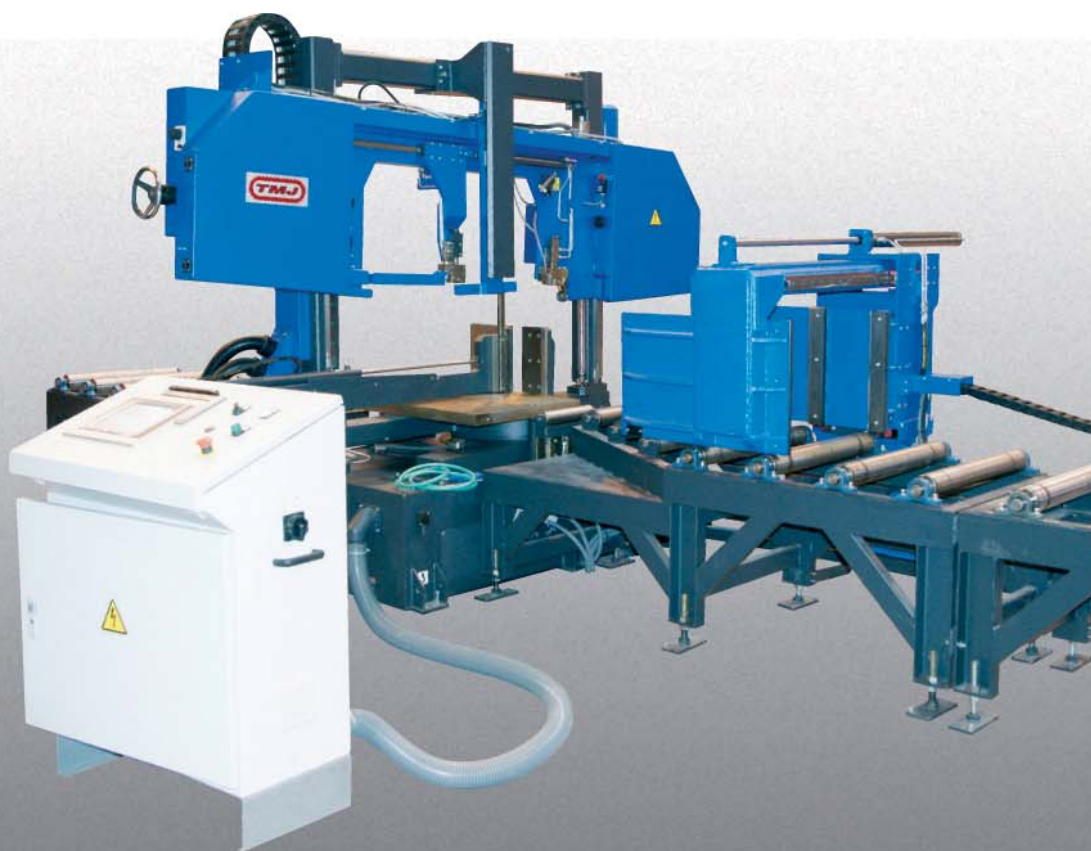

PP 620 DG

	90°	-45°	+45°	+60°
●	450	450	450	320
■	450	450	450	320
■	620×450	450×410	450×450	320×450

400 V / 4 kW	9–90 m/min.	3600 kg

PP 620 DGA

	90°	-45°	+45°	+60°
●	450	450	450	320
■	450	450	450	320
■	620×450	450×450	450×450	320×450

400 V / 4 kW	9–90 m/min.	3600 kg

AWD 4.2 CNC



5940×41×1,3

4.2 CNC

9950×67×1,6

8.2 CNC

8200×54×1,6

6.2 CNC

12500×80×1,6

10.2 CNC



AWD 6.2 CNC

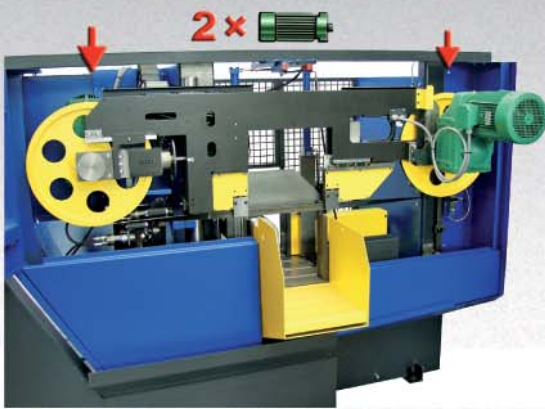

	● ■	2x	AWD System	kg
AWD 4.2 CNC	410	2x5,5 kW	10-170 m/min.	4600 kg
AWD 6.2 CNC	620	2x7,5 kW	10-170 m/min.	5800 kg
AWD 8.2 CNC	820	2x8,6 kW	10-135 m/min.	8900 kg
AWD 10.2 CNC	1020	2x11 kW	10-135 m/min.	14500 kg

PP 1100



11060×67×1,6



PP 700



8200×54×1,6



PP 1100		90°	
●	1100	■	400 V / 11 kW
■	1100	▬	10-75 m/min.
▬	1100×1100	kg	14500 kg

PP 700		90°	
●	700	■	400 V / 7,5 kW
■	700	▬	15-110 m/min.
▬	700×700	kg	7500 kg

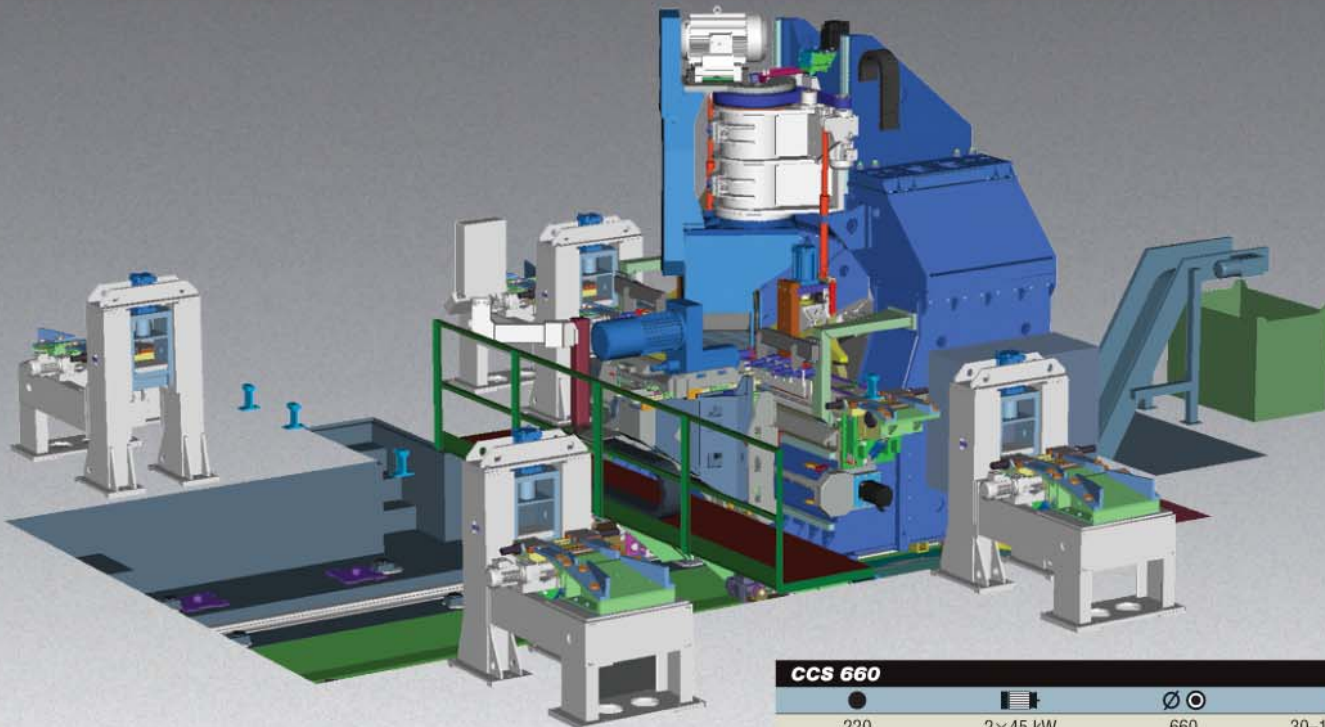

CCS 660				
220	2×45 kW	660	30–120 m/min.	



Gantry

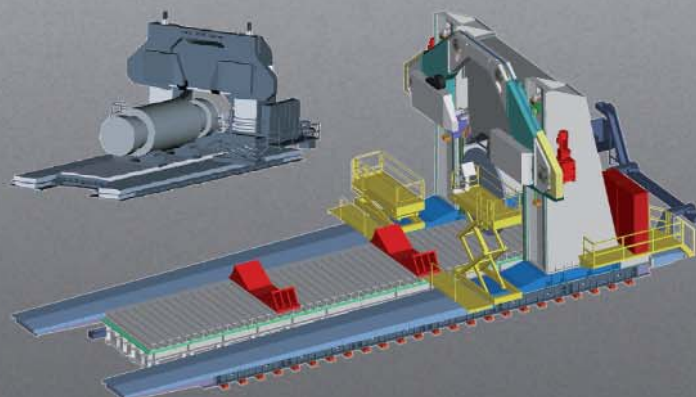
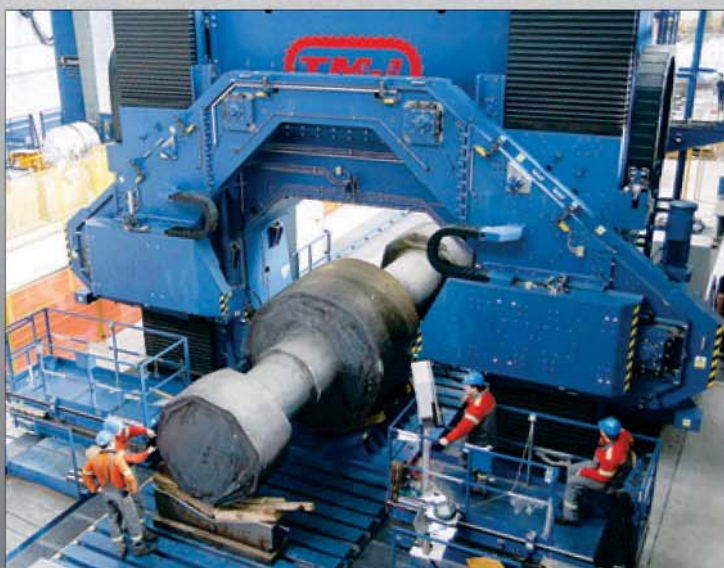

Gantry 3318	90°
	3300
	3300×3300

Gantry 2018	90°
	2000
	2000×2000

Systematic

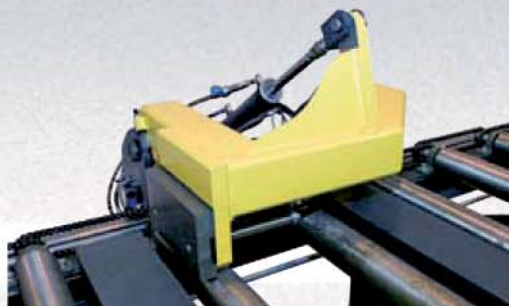
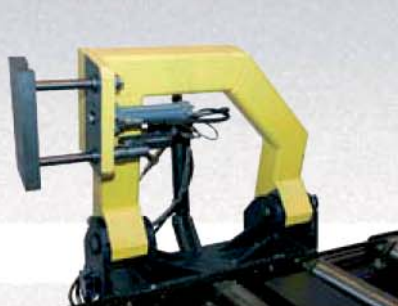

EcoDrill ED 1250

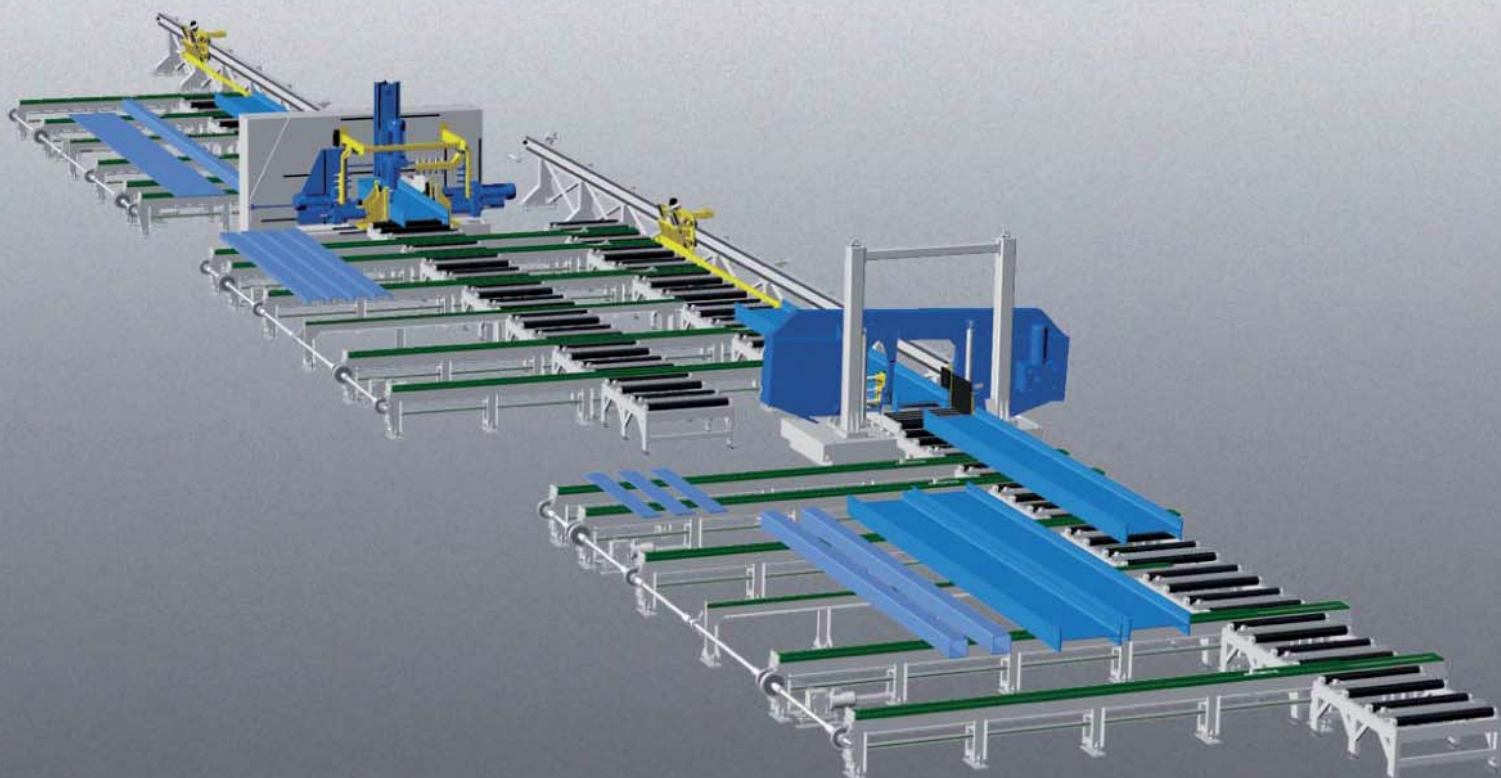

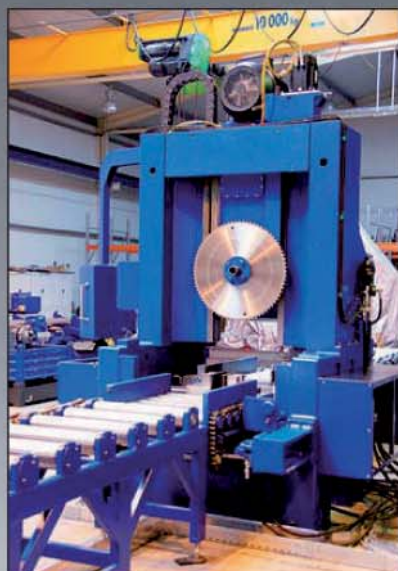

TMJ KA 800 CNC				
●	■	▨	⊙	⊕
420	380×380	400 V / 55 kW	1180	50–320 m/min.

RB 500



RBL

RBM 500



RB 700

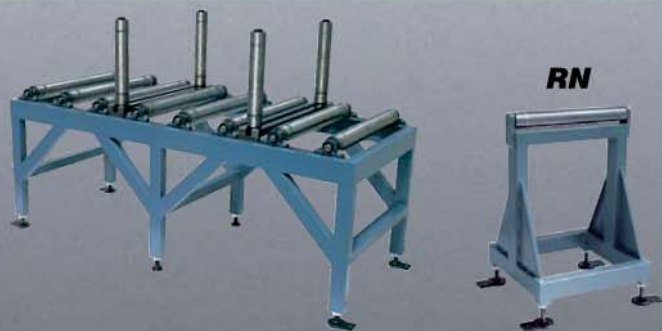

RN

RBM 700



	RB 500	RB 700	RB 1000	RB 1300	RN 500	RN 700
mm	2000	2000	2000	2000	–	–
mm	500	700	1000	1300	560	700
∅	58	100	100	100	58	100
12...x	6	6	6	6	–	–
kg/m	5400	19200	28000	10800	1000	3000
mm	700–915	700	700	700	700	700

	RBM 500	RBM 700	RBM 1000
mm	2000	2000	2000
mm	500	710	1020
∅	58	100	128
12...x	6	6	6
kg/m	5400	19200	28000
kw	0,55	1,1	1,5
mm	700	700	700



OH 90



OHE 90



LA 50



Emulsion



Microspray



	OH 90	OHE 90
	400 V / 2,2 kW	400 V / 2,2 kW
	1400/min.	1400/min.
	∅ 200 mm	∅ 200 mm
	60 kg	47 kg

	90
	90

OK 100



OK 120



OK 100		
		100×5
		∅ 15
		14×14
		max. 120°
		R1 / R6,5 / R10
		R15 / R20 / R25
		280×290×220
		30 kg

OK 100		
		120×8
		∅ 20
		20×20
		max. 120°
		R1 / R6,5 / R10
		R15 / R20 / R25
		450×440×250
		60 kg

M 280

M 280 AB

MS 280

MO 280

	M 200		M 280		M 400	
	1500	3000	1500	3000	1500	3000
	200	200	280	280	400	400
	50	50	50	50	60	60
	6	12	6	12	6	12
	1	2	1	2	1	2
	4	7	4	7	4	7
	875-915					



N 280

K 400

KO 400

	K 400	KO 400
	2000	2000
	400	400
	60	60
	6	6
	2	2
	4	-
	760-960	



	MO		
	2000	3000	6000
	200	200	200
	280	280	280
	350	350	-
	50	50	50
	10	13	25
	1	2	3
	875-915		

GP 1000

G 1000

GV



	GP 1000		GPS 1000	
	2000	3000	2000	3000
	1000	1000	1000	1000
	98	98	98	98
	6	8	4	6
	3	3	3	3
	760-830		760-830	



Metal



Wood



Pilous-TMJ s.r.o.

CENTRAL OFFICE BRNO
 Železná 9, 619 00 Brno, Czech Republic
 Tel.: +420 543 252 010, Fax: +420 543 252 011
 e-mail: pilous@pilous.cz

www.pilous.cz

OFFICE JESENICE
 Zahradní 438, 270 33 Jesenice, Czech Republic
 Tel.: +420 313 599 000, Fax: +420 313 599 357
 e-mail: tmjesenice@tmj.cz

Subject to modifications