



PILOUS  [®]
PROFESSIONAL BANDSAWS



2020
Made in EU
Czech Republic

**25 YEARS OF
EXPERIENCES**

ARG 105 mobil



ARG 105 mobil

	90°	+45°	+60°
●	105	70	40
■	105×110	65×85	40×45

ARG 130 / super



ARG 130 / super / mobil

	90°	+45°	+60°
●	130	115	70
■	180×100	115×75	70×60

ARG 130 mobil



ARG 130 mobil

	90°	+45°	+60°
●	130	115	70
■	180×100	115×75	70×60

ARG 200 plus



ARG 200 plus

	90°	-45°	+45°	+60°
●	200	135	155	95
■	250×140	150×70	160×125	100×60

ARG 235



ARG 235

	90°	+45°	+60°
●	235	185	115
■	280×180	185×100	115×80

ARG 235 plus



ARG 235 plus

	90°	-45°	+45°	+60°
●	235	165	185	115
■	280×180	185×80	185×100	115×80

ARG 260



ARG 260 / H / H.F.

	90°	+45°	+60°
●	260	200	125
■	300×200	185×200	125×120

ARG 260 plus E



ARG 260 plus E

	90°	-45°	+45°	+60°
●	260	180	200	125
■	300×185	190×105	185×195	125×105

ARG 260 plus



ARG 260 plus / H / H.F.

	90°	-45°	+45°	+60°
●	260	175	200	125
■	300×200	190×100	185×200	125×120

ARG 260 plus S.A.F.

2880×27×0,9



ARG 260 plus S.A.F.

	90°	-45°	+45°	+60°
●	260	175	200	125
■	300×200	190×100	185×200	125×120

ARG 300 F

3150×27×0,9



ARG 300 F / H.F. / S.A.F.

	90°	+45°	+60°
●	300	240	155
■	375×190	240×160	150×150

ARG 300 plus F

3150×27×0,9



ARG 300 plus F / H.F.

	90°	-45°	+45°	+60°
●	300	220	240	155
■	375×190	240×100	240×160	150×150

ARG 300 plus S.A.F.

3150×27×0,9



ARG 300 plus S.A.F.

	90°	-45°	+45°	+60°
●	300	220	240	155
■	375×190	240×100	240×160	150×150

ARG 330 F

3870×34×1,1



ARG 330 F / H.F. / S.A.F.

	90°	+45°	+60°
●	330	250	165
■	400×200	250×170	150×150

ARG 330 plus S.A.F.

3870×34×1,1



ARG 330 plus F / H.F. / S.A.F.

	90°	-45°	+45°	+60°
●	330	240	250	165
■	400×200	250×140	250×170	150×150

ARG 330 DC S.A.F.

3870×34×1,1



ARG 330 DC S.A.F.

	90°
●	330
■	360×310

ARG 260 CF-NC automat



2880×27×0.9



ARG 260 CF-NC automat

SERVO system

	90°	+45°
●	260	180
■	245×250	180×120

ARG 300 CF-NC automat



3150×27×0.9



ARG 300 CF-NC automat

SERVO system

	90°	+45°
●	300	240
■	305×290	235×130

ARG 300 DCT CF-NC automat



3150×27×0.9



ARG 300 DCT CF-NC automat

SERVO system

	90°	+45°
●	300	245
■	360×295	245×250



MASTER 3.0



3150×27×0.9

MASTER 3.0

SERVO system

	90°	+45°
●	300	240
■	305×290	235×130

ARG 330 CF-NC automat



3870×34×1.1



ARG 330 CF-NC automat

SERVO system

	90°	+45°
●	330	250
■	360×250	250×150

ARG 330 DC CF-NC automat



3870×34×1.1



ARG 330 DC CF-NC automat

SERVO system

	90°
●	330
■	360×310

FAZER 3.9



6040×41×1.3



FAZER 3.9

SERVO system

	90°
●	390
■	450×390

ARG 400 plus S.A.F.



4300×34×1,1



ARG 400 plus S.A.F.

	90°	-45°	+45°	+60°
●	400	290	300	200
■	460×300	300×170	300×200	200×200

ARG 380 plus S.A.F.



4950×34×1,1



ARG 380 plus S.A.F.

	90°	-45°	+45°	±60°
●	380	380	380	270
■	510×340	350×340	350×340	235×340

ARG 500 plus S.A.F.



6040×41×1,3



ARG 500 plus S.A.F.

	90°	-45°	+45°	±60°
●	500	500	500	350
■	620×450	440×450	430×450	310×400

XPERT 3.0 3D



XPERT 3.0 3D

■	360×300
---	---------

ARG I100 special

6760×34×1,1

6760×41×1,3



ARG I100 special

1100×100 (400)

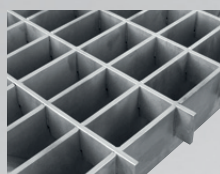

IR 200



max. 200 mm

ARG 450 DC plus CF-NC automat



6420×41×1,3

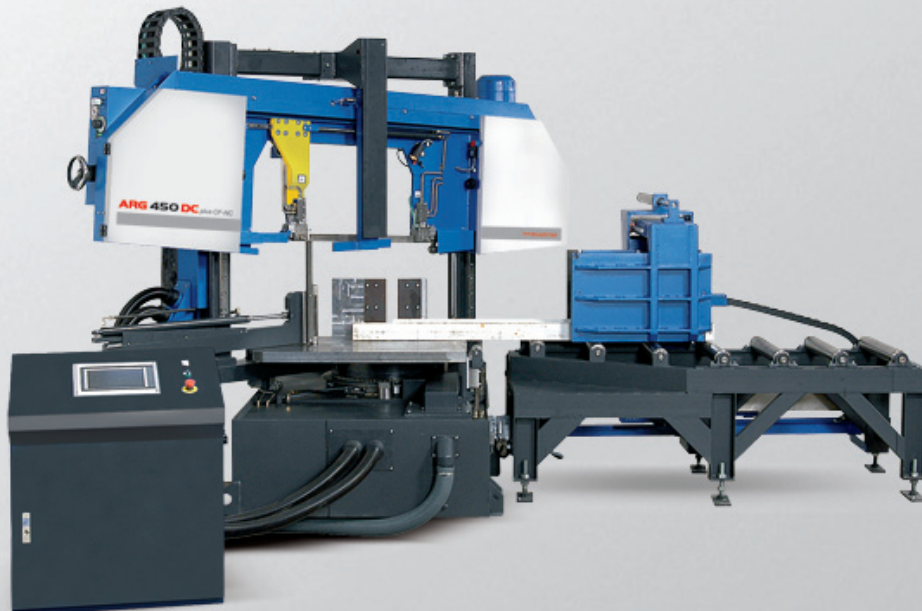

ARG 520 DC S.A.F.



5770×41×1,3



ARG 520 DC CF-NC automat

5770×41×1,3



ARG 600 DC CF-NC automat

6200×41×1,3

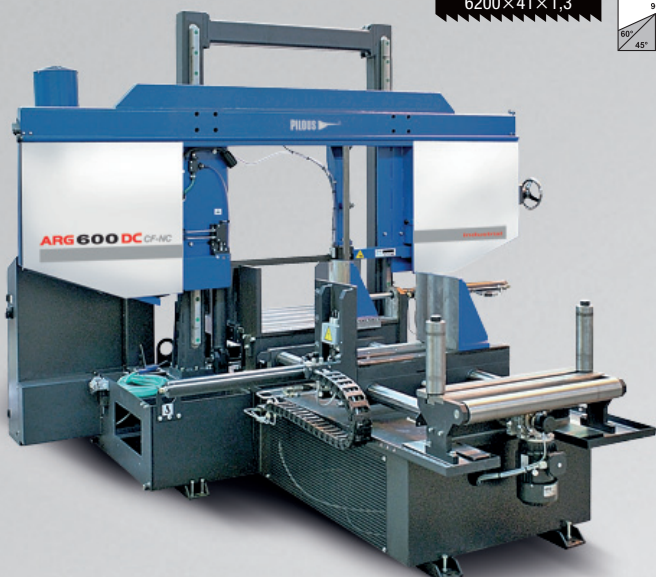

ARG 450 DC plus CF-NC automat

	90°	-45°	+45°	+60°
●	450	450	450	320
■	620×450	450×410	450×450	320×450

ARG 520 DC S.A.F. / ARG 520 DC CF-NC automat

	90°
●	520
■	700×480

ARG 600 DC S.A.F. / ARG 600 DC CF-NC automat

	90°
●	600
■	600×680

ARG 640 DCT S.A.F.



8100×54×1.6



ARG 700 DC S.A.F.



8200×54×1.6



ARG 700 DC CF-NC automat



8200×54×1.6

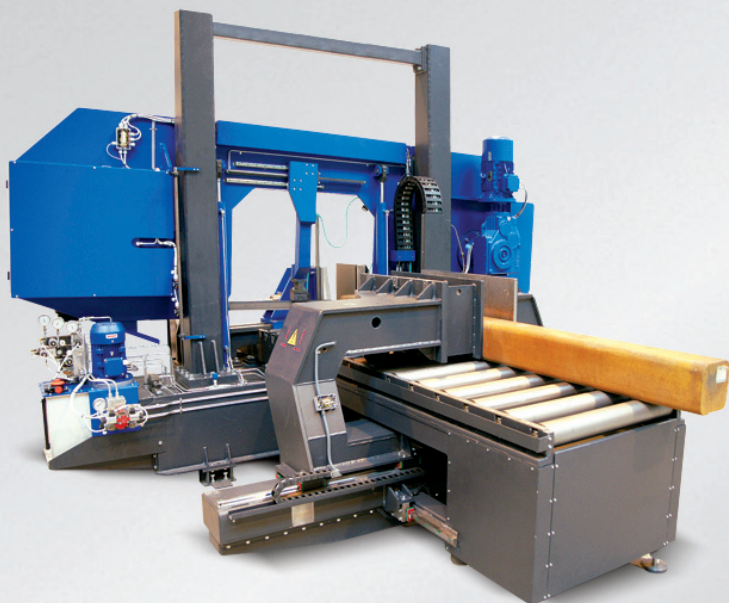

ARG 1100 DC S.A.F.



11060×67×1.6

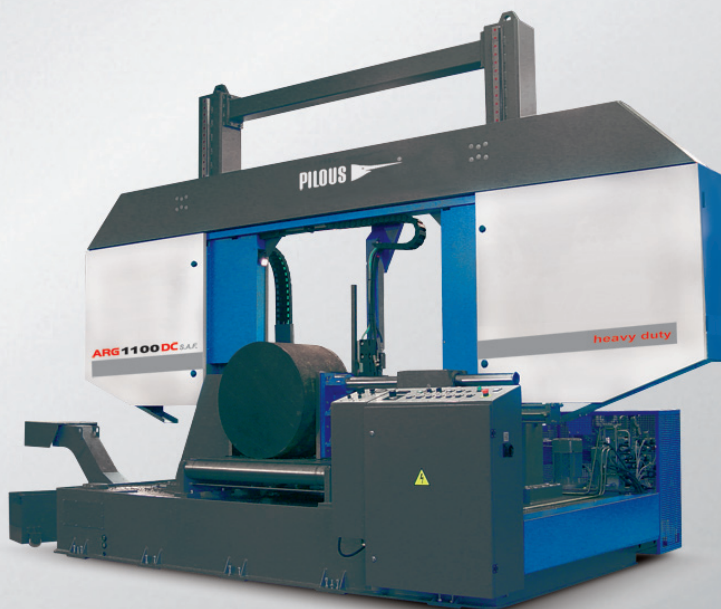

ARG 640 DCT S.A.F.

	90°	-45°	-60°
●	640	640	375
■	1100×550	710×550	375×550

ARG 700 DC S.A.F.

	90°
●	700
■	700×750

ARG 700 DC CF-NC automat

	90°
●	700
■	700×750

ARG 1100 DC S.A.F.

	90°
●	1100
■	1100×1100

CONVEYORS

Systém M



Systém D



OH 90

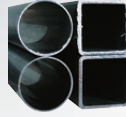

OHE 90



OH / OHE 90

(mm)

90

DO



DOD



D

(mm)

2000

3000

200, 300, 400

Systém K

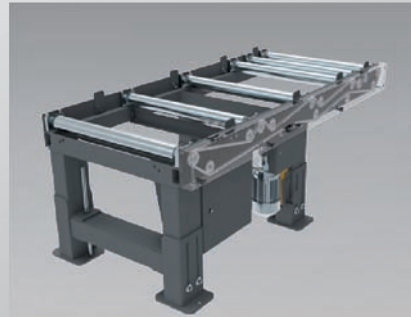

KO

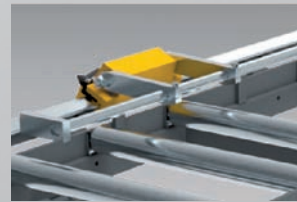

KOD



K

(mm)

1000

2000

400, 520, 650, 750

Systém G



GV



KR



G

(mm)

2000

3000

1000

EMULSION



COOLcut Standard



COOLcut Opti



COOLcut Eco 65



COOLcut Bio 90



COOLcut Micro



COOLcut Antifreeze



Metal

Wood

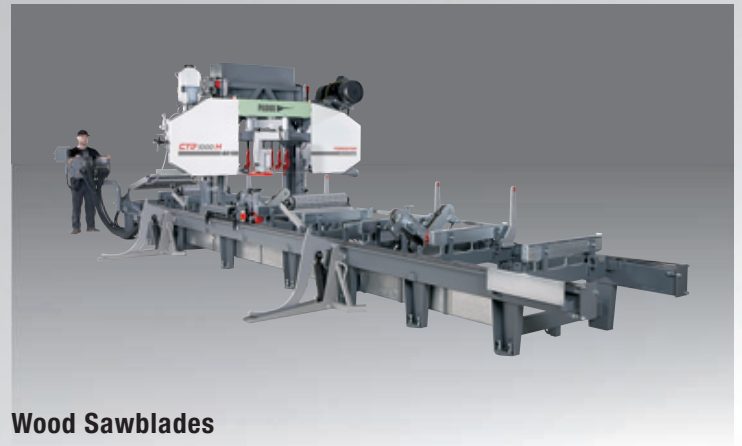

Metal Sawblades

Wood Sawblades

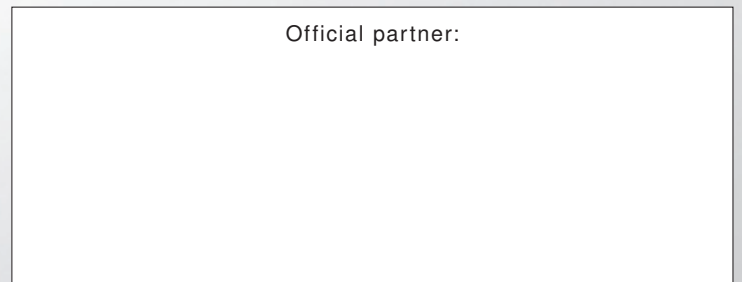

Official partner: